

# Data sheet

## LITHIUM POLYMER BATTERY

PART NUMBER: LP632570

**1 YEAR  
WARRANTY**

### ELECTRICAL CHARACTERISTICS

RATED CAPACITY	1200mAh
NOMINAL VOLTAGE	3.7V
WATT-HOUR RATING	4 Wh
MAX. OPERATING VOLTAGE RANGE	2.75V -4.20V
PULSE DISCHARGE CURRENT	3C(1mS)
MAX. CHARGE CURRENT	0.5C
MAX. CONTINUOUS DISCHARGE CURRENT	1C
INTERNAL IMPEDANCE	<60m $\Omega$
EXPECTED CYCLE LIFE(23 $\pm$ 5 $^{\circ}$ C)	500(0.2C)

### MECHANICAL CHARACTERISTICS

DIMENSIONS	72 x 25 x 6 mm
PCM	YES
TERMINALS	WC/FL*
WEIGHT	20 g

\*WC=With Connector FL=Flying Leads

### CELL PROTECTION

OVER CHARGE DEFECTION	4.275 $\pm$ 50mV
OVER DISCHARGE DEFECTION	2.5V $\pm$ 50mV
OVER CURRENT DEFECTION	3A-5A
SHORT CIRCUIT DEFECTION	YES

### AMBIENT CODITIONS

CHARGE TEMP. RANGE	0 $\sim$ +45 $^{\circ}$ C
DISCHARGE TEMP. RANGE	-20 $\sim$ +60 $^{\circ}$ C
STORAGE TEMP. RANGE	0 $\sim$ +35 $^{\circ}$ C (per year)
HUMIDITY	65 $\pm$ 20%RH

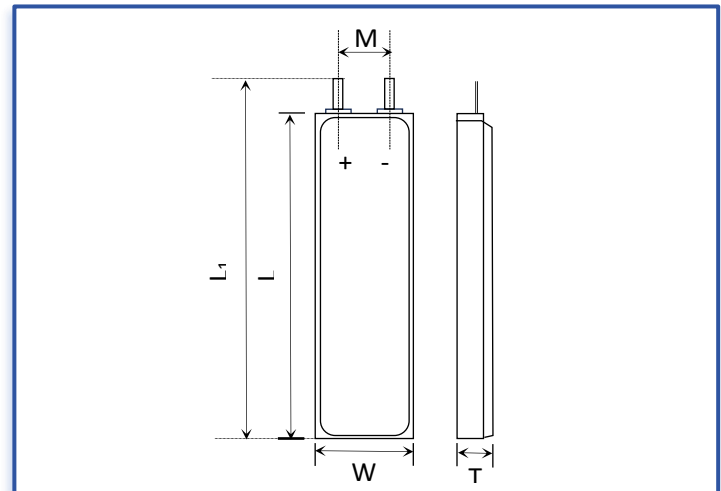

Item	Parameter (mm)
T	6
W	25
M	5
L	70
L <sub>1</sub>	72
BL	72 $\pm$ 1
CL	100

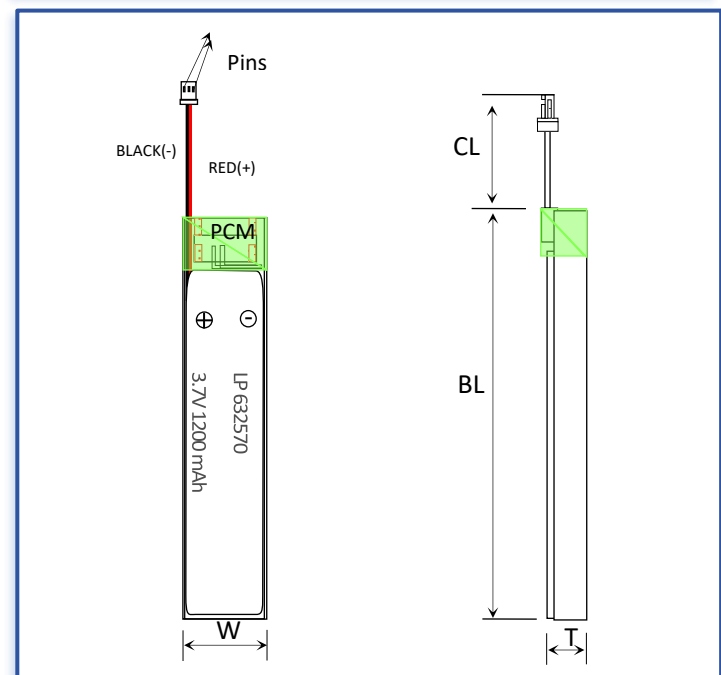

\*Specifications are subject to change without notice.

# CONTACT

CUSTOMER SERVICE  
+86 755 3682 7358  
sales@fpbattery.com

LEARN MORE ON:  
www.fpbattery.com  
LP POWER COMPANY LIMITED